

Series 800
Sections



Project-In
Details

Page No.
8B2

Win-Vent Architectural Windows 2401 S. Main Street Fort Scott Kansas 66701
(620) 223-1111 (800) 295-3113 Fax (620) 223-1139 www.winventwindows.com

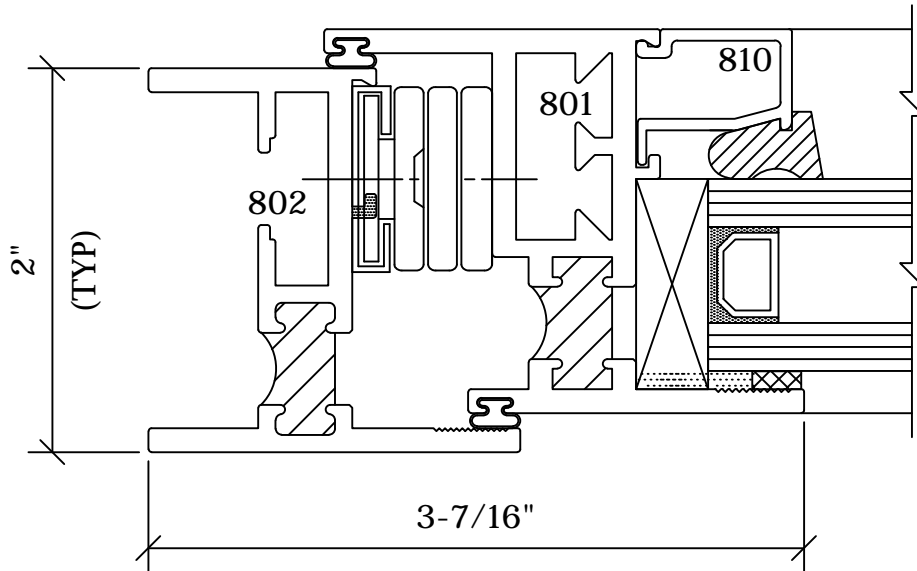

3 JAMB
8B2

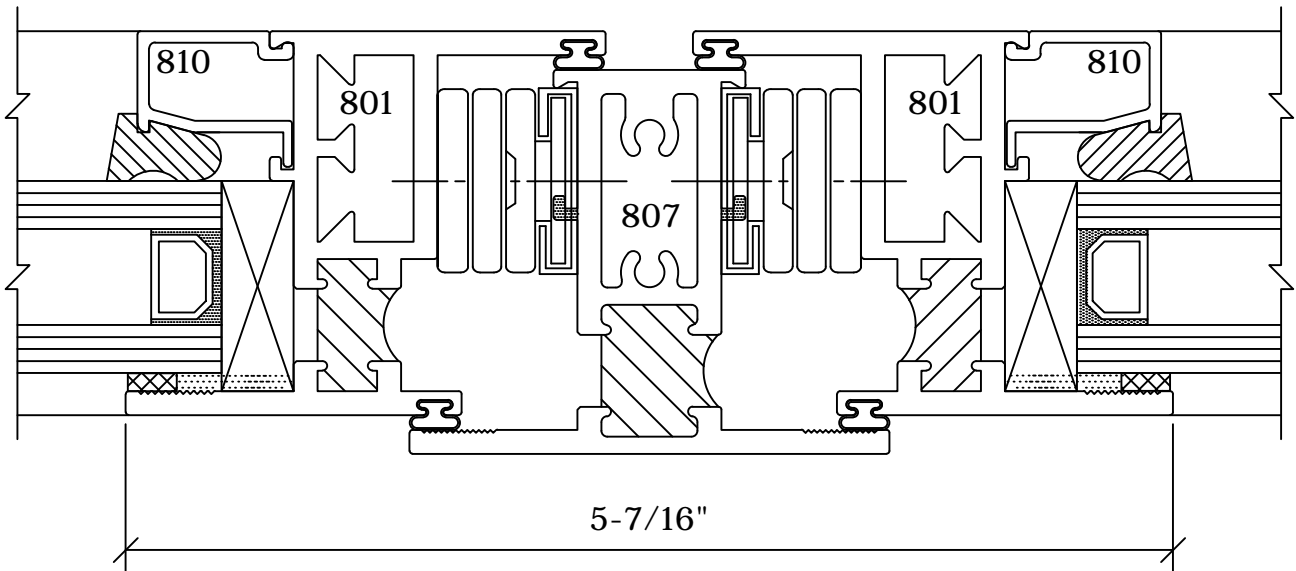

4 VERTICAL MUNTIN
8B2